

Application Notes

OSI Optoelectronics, is a leading manufacturer of fiber optic components for communication systems. The products offer range for Silicon, GaAs and InGaAs to full turnkey solutions.

Photodiodes are semiconductor devices responsive to high energy particles and photons. Photodiodes operate by absorption of photons or charged particles and generate a flow of current in an external circuit, proportional to the incident power. Planar diffused silicon photodiodes are P-N junction diodes. A P-N junction can be formed by diffusing either a P-type impurity, such as Boron, into a N-type bulk or epitaxial silicon wafer, or a N-type impurity, such as Phosphorus, into a P-type bulk or epitaxial wafer. The diffused area defines the photodiode active area. To form an ohmic contact, another impurity diffusion into the backside of the wafer is necessary. The active area is coated with an Anti-Reflection coating to reduce the reflection of the light for a specific predefined wavelength. The P and N-sides of the junction have metal pads, which make an electrical contact through dielectric layers.

For applications within the wavelength range of $1.3\mu\text{m} - 1.55\mu\text{m}$, photodiodes made on InGaAs/InP material are widely used due to the superior speed, responsivity and low noise characteristics. **Figure 1.1** shows the schematic cross-section of OSI Optoelectronics's InGaAs/InP photodiode.

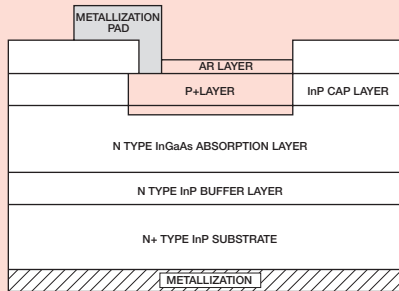

Figure 1.1

Due to the high absorption coefficient, the InGaAs absorption region is typically a few micrometers thick. The thin absorption layer enables the device to obtain high speed at a low reverse bias voltage, typically 2-5 volts. The InP window layer is transparent to $1.3\mu\text{m} - 1.55\mu\text{m}$ wavelengths, thus InGaAs/InP photodiodes do not have slow tail impulse response associated with the slow diffusion component from the contact layer.

Typical Spectral Responsivity (Si)

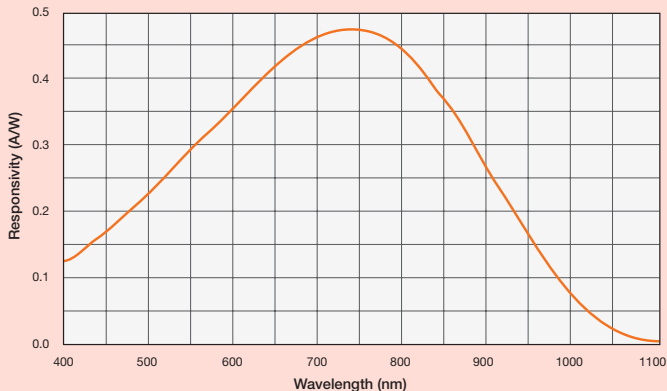

Figure 1.2

Typical Spectral Responsivity (GaAs)

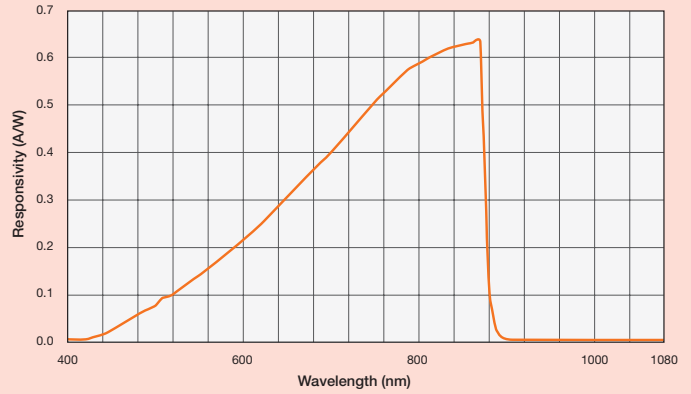

Figure 1.3

Typical Spectral Responsivity (InGaAs)

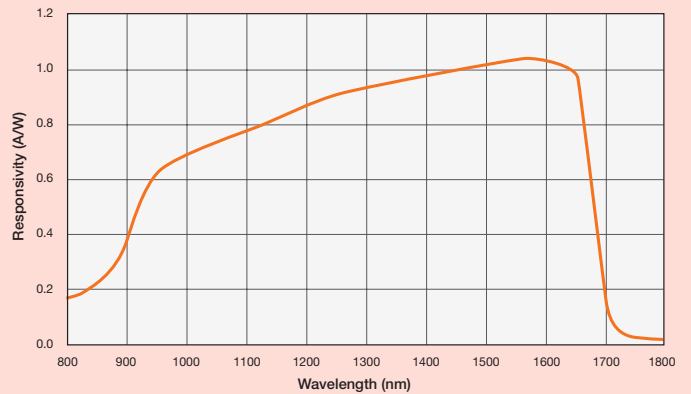

Figure 1.4

The typical spectral response curves of Silicon, GaAs, and InGaAs photodiodes are shown in Figures 1.2, 1.3, 1.4. The bandgap energies of Si, GaAs, and InGaAs are 1.12eV, 1.42eV, and 0.75eV respectively. The cutoff wavelengths of photodiodes made from these materials are $1.10\mu\text{m}$ for Si, $0.87\mu\text{m}$ for GaAs, and $1.65\mu\text{m}$ for InGaAs

OSI Optoelectronics's InGaAs/InP photodiodes are planar passivated. The dark current is low and very stable. **Figure 1.5** shows the typical dark current of FCI-InGaAs-500 as a function of reverse bias voltage. The relationship between dark current and temperature is shown in **Figure 1.6**.

Typical Dark Current vs. Reverse Bias Voltage (500m InGaAs in TO-package)

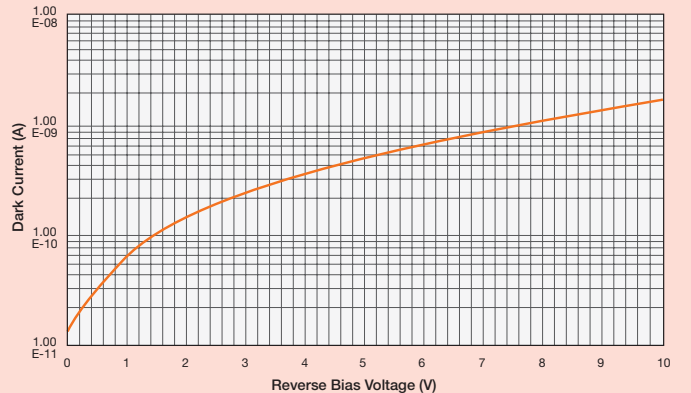

Figure 1.5

Typical Dark Current vs. Temperature (V_s=-5V, 500m InGaAs in TO-package)

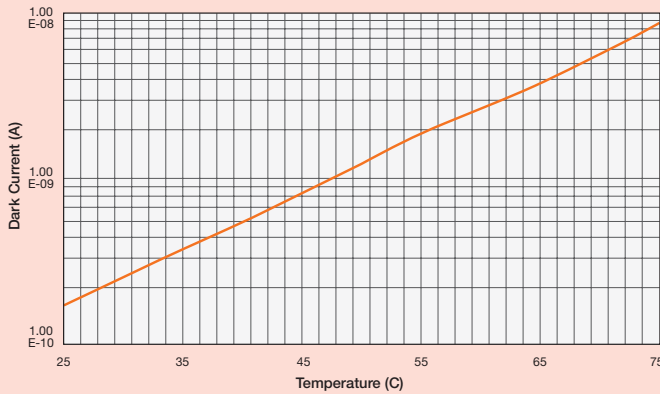

Figure 1.6

Electrical Characteristics

A p-n junction photodiode can be represented by a current source in parallel with an ideal diode (Figure 1.7). The current source represents the current generated by the incident photons, and the diode represents the p-n junction. In addition, a junction capacitance C_j and a shunt resistance R_{sh} are in parallel with the other components. Series resistance R_s is connected in series with all components in this model.

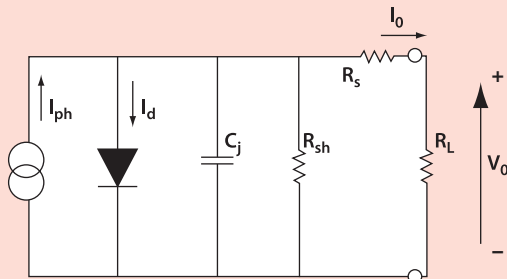

Figure 1.7

Shunt Resistance, R_{sh}

Shunt resistance is the slope of the current-voltage curve of the photodiode at the origin, i.e. V=0. Although an ideal photodiode should have a shunt resistance of infinite, actual values range from 10s to 1000s of Mega ohms. Experimentally it is usually obtained by applying ±10mV, measuring the current and calculating the resistance. Shunt resistance is used to determine the noise current in the photodiode with no bias (photovoltaic mode). For best photodiode performance the highest shunt resistance is desired.

Series Resistance, R_s

Series resistance of a photodiode arises from the resistance of the contacts and the resistance of the undepleted semiconductors. It is given by:

$$R_s = \frac{(W_s - W_d) \rho}{A} + R_c$$

Where W_s is the thickness of the substrate, W_d is the width of the depleted region, A is the diffused area of the junction, ρ is the resistivity of the substrate and R_c is the contact resistance. Series resistance is used to determine the rise time and the linearity of the photodiode.

Junction Capacitance, C_j

The boundaries of the depletion region act as the plates of a parallel plate capacitor. The junction capacitance is directly proportional to the diffused area and inversely proportional to the width of the depletion region. The capacitance is dependent on the reverse bias as follows:

$$C_j = \frac{\epsilon \epsilon_0 A}{\sqrt{2\epsilon \epsilon_0 \mu \rho (V_A + V_{bi})}}$$

Where ε₀ is the permittivity of free space, ε is the semiconductor dielectric constant, μ is the mobility of the majority carriers, ρ is the resistivity, V_{bi} is the built-in voltage of the semiconductor of the P-N junction and V_A is the applied bias. Figure 1.8 shows the typical capacitance of FCI-InGaAs-500 as a function of the applied reverse bias voltage. Junction capacitance is used to determine the speed of the response of the photodiode.

Typical Capacitance vs. Reverse Bias Voltage (at f=1MHz, 500m InGaAs in TO-package)

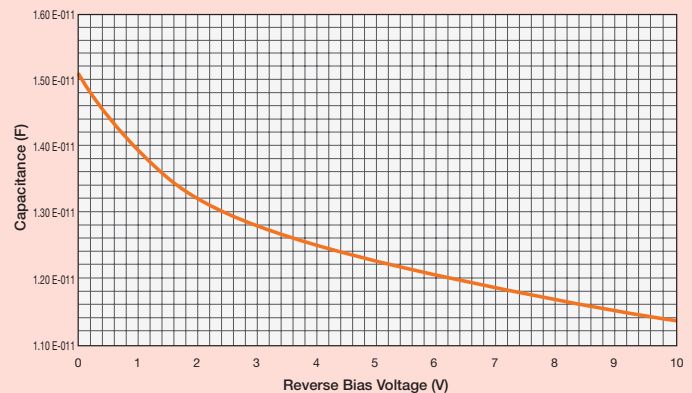

Figure 1.8

Rise/Fall time and Frequency Response, t_r / t_f / f_{3dB}

The rise time and fall time of a photodiode is defined as the time for the signal to rise or fall from 10% to 90% or 90% to 10% of the final value respectively. This parameter can be also expressed as frequency response, which is the frequency at which the photodiode output decreased by 3dB. It is roughly approximated by:

$$t_r = \frac{0.35}{f_{3dB}}$$

Application Notes

These are three factors defining the response time of a photodiode:

1. t_{DRIFT} , the drifting time of the carriers in the depleted region of the photodiode.
2. $t_{DIFFUSED}$, the charge collection time of the carriers in the undepleted region of the photodiode.
3. t_{RC} , the RC time constant of the diode-circuit combination.

t_{RC} is determined by $t_{RC}=2.2RC$, where R is the sum of the diode series resistance and the load resistance (R_s+R_L), and C is the sum of the photodiode junction and the stray capacitances (C_j+C_s). Since the junction capacitance (C_j) is dependent on the diffused area of the photodiode and the applied reverse bias, faster rise times are obtained with smaller diffused area photodiodes, and larger applied biases. In addition, stray capacitance can be minimized by using short leads, and careful lay-out of the electronic components. The total rise time is determined by:

$$t_r = \sqrt{t_{DRIFT}^2 + t_{DIFFUSED}^2 + t_{RC}^2}$$

Noise

In a photodiode two sources of noise can be identified. Shot noise and Johnson noise:

Shot Noise

Shot noise is related to the statistical fluctuation in both the photocurrent and the dark current. The magnitude of the shot noise is expressed as the root mean square (rms) noise current:

$$I_{sn} = \sqrt{2q(I_p + I_d)\Delta f}$$

Where $q=1.6 \times 10^{-19}C$ is the electron charge, I_p is the photogenerated current, I_d is the photodetector dark current and Δf is the noise measurement bandwidth.

Thermal or Johnson Noise

The shunt resistance in the photodetector has a Johnson noise associated with it. This is due to the thermal generation of carriers. The magnitude of the generated current noise is:

$$I_{jn} = \sqrt{\frac{4k_B T \Delta f}{R_{sh}}}$$

Where $k_B=1.38 \times 10^{-23}J/K$, is the Boltzmann Constant, T is the absolute temperature in degrees Kelvin ($273K=0^\circ C$), Δf is the noise measurement bandwidth, and R_{sh} is the shunt resistance of the photodiode. This type of noise is the dominant current noise in photovoltaic (unbias) operation mode.

Note: All resistors have a Johnson noise associated with them, including the load resistor. This additional noise current is large and adds to the Johnson noise current caused by the photodetector shunt resistance.

Total Noise

The total noise current generated in a photodetector is determined by:

$$I_{tn} = \sqrt{I_{sn}^2 + I_{jn}^2}$$

Noise Equivalent Power (NEP)

Noise Equivalent Power is the amount of incident light power on a photodetector, which generates a photocurrent equal to the noise current. NEP is defined as:

$$NEP = \frac{I_{tn}}{R_\lambda}$$

Where R_λ is the responsivity in A/W and I_{tn} is the total noise of the photodetector. For InGaAs photodiodes, NEP values can vary from $10^{-14}W/\sqrt{Hz}$ for large active area down to $10^{-15}W/\sqrt{Hz}$ for small active area photodiodes.

TEMPERATURE EFFECTS

All photodiode characteristics are affected by changes in temperature. They include shunt resistance, dark current, breakdown voltage, and to a lesser extent other parameters such as junction capacitance.

Shunt Resistance and Dark Current:

There are two major currents in a photodiode contributing to dark current and shunt resistance. Diffusion current is the dominating factor in a photovoltaic (unbiased) mode of operation, which determines the shunt resistance. It varies as the square of the temperature. In photoconductive mode (reverse biased), however, the drift current becomes the dominant current (dark current) and varies directly with temperature. Thus, change in temperature affects the photodetector more in photovoltaic mode than in photoconductive mode of operation.

In photoconductive mode the dark current may approximately double for every $10^\circ C$ increase change in temperature. And in photovoltaic mode, shunt resistance may approximately double for every $6^\circ C$ decrease in temperature. The exact change is dependent on additional parameters such as the applied reverse bias, resistivity of the substrate as well as the thickness of the substrate.

Breakdown Voltage:

For small active area devices, breakdown voltage is defined as the voltage at which the dark current becomes $10\mu A$. Since dark current increases with temperature, therefore, breakdown voltage decreases similarly with increase in temperature.

RESPONSIVITY, R_λ

The responsivity of a photodiode is a measure of the sensitivity to light, and it is defined as the ratio of the photocurrent I_P to the incident light power P at a given wavelength:

$$R_\lambda = \frac{I_P}{P}$$

In another words, it is a measure of the effectiveness of the conversion of the light power into electrical current. It varies with the wavelength of the incident light as well as applied reverse bias and temperature.

Responsivity increases slightly with applied reverse bias due to improved charge collection efficiency in photodiode. Also there are responsivity variations due to change in temperature as shown in **Figure 1.9**. This is due to decrease or increase of the band gap, because of increase or decrease in the temperature respectively. Spectral responsivity may vary from lot to lot and it is dependent on wavelength. However, the relative variations in responsivity can be reduced to less than 1% on a selected basis.

Spectral Response vs. Temperature for InGaAs

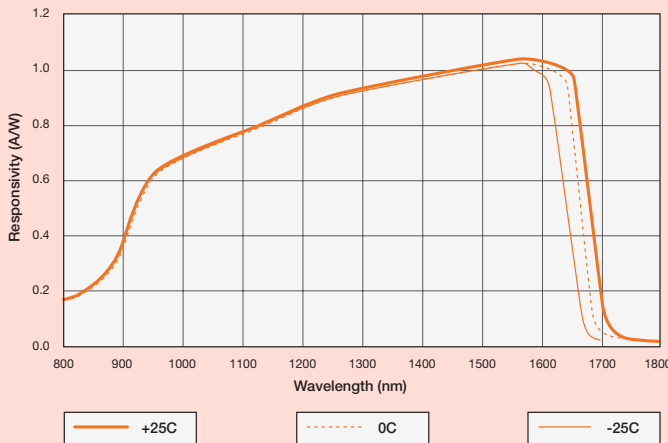

Figure 1.9. Typical Spectral Response versus Temperature for InGaAs

BIASING

A photodiode signal can be measured as a voltage or a current. Current measurement demonstrates far better linearity, offset, and bandwidth performance. The generated photocurrent is proportional to the incident light power and it must be converted to voltage using a transimpedance configuration. The photodiode can be operated with or without an applied reverse bias depending on the application specific requirements. They are referred to as “Photoconductive” (biased) and “Photovoltaic” (unbiased) modes.

Photoconductive Mode (PC)

Application of a reverse bias (i.e. cathode positive, anode negative) can greatly improve the speed of response and linearity of the devices. This is due to increase in the depletion region width and consequently decrease in junction capacitance. Applying a reverse bias, however, will increase the dark and noise currents. An example of low light level / high-speed response operated in photoconductive mode is shown in **Figure 1.10**.

In this configuration the detector is biased to reduce junction capacitance thus reducing noise and rise time (t_r). A two stage amplification is used in this example since a high gain with a wide bandwidth is required. The two stages include a transimpedance pre-amp for current- to-voltage conversion and a non-inverting amplifier for voltage amplification. Gain and bandwidth ($f_{3dB Max}$) are directly determined by R_F . The gain of the second stage is approximated by $1 + R_1 / R_2$. A feedback capacitor (C_F) will limit the frequency response and avoids gain peaking.

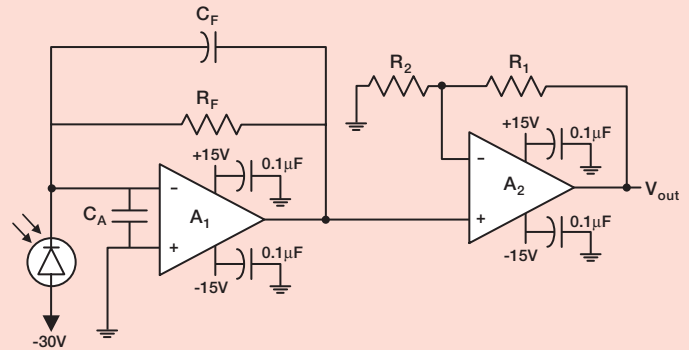

Figure 1.10. Photoconductive mode of operation circuit example: Low Light Level / Wide Bandwidth

$$f_{3dBMax} [Hz] = \sqrt{\frac{GBP}{2\pi R_F (C_J + C_F + C_A)}}$$

Where GBP is the Gain Bandwidth Product of amplifier (A_1) and C_A is the amplifier input capacitance.

$$Gain(V/W) = \frac{V_{OUT}}{P} = R_F \left(1 + \frac{R_1}{R_2}\right) R_\lambda$$

In low speed applications, a large gain, e.g. $>10M\Omega$ can be achieved by introducing a large value (R_F) without the need for the second stage.

Application Notes

Typical components used in this configuration are:

Amplifier: CLC-425, CLC-446, OPA-637, or similar
 RF: 1 to 10 kΩ Typical, depending on C₁
 R1: 10 to 50 kΩ
 R2: 0.5 to 10 kΩ
 CF: 0.2 to 2 pF

In high speed, high light level measurements, however, a different approach is preferred. The most common example is pulse width measurements of short pulse gas lasers, solid state laser diodes, or any other similar short pulse light source. The photodiode output can be either directly connected to an oscilloscope (**Figure 1.11**) or fed to a fast response amplifier. When using an oscilloscope, the bandwidth of the scope can be adjusted to the pulse width of the light source for maximum signal to noise ratio. In this application the bias voltage is large. Two opposing protection diodes should be connected to the input of the oscilloscope across the input and ground.

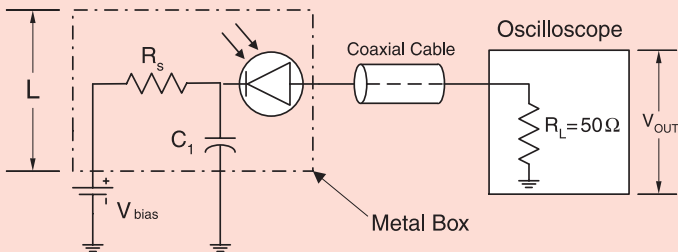

Figure 1.11. Photoconductive mode of operation circuit example: High Light Level / High Speed Response

To avoid ringing in the output signal, the cable between the detector and the oscilloscope should be short (i.e. < 20cm) and terminated with a 50 ohm load resistor (R_L). The photodiode should be enclosed in a metallic box, if possible, with short leads between the detector and the capacitor, and between the detector and the coaxial cable. The metallic box should be tied through a capacitor (C₁), with lead length (L) less than 2 cm, where R_L C₁ > 10 t (t is the pulse width in seconds). R_s is chosen such that R_s < V_{BIAS} / 10 I_{PDC}, where I_{PDC} is the DC photocurrent. Bandwidth is defined as 0.35 / t. A minimum of 10V reverse bias is necessary for this application. Note that a bias larger than the photodiode maximum reverse voltage should not be applied.

Photovoltaic Mode (PV)

The photovoltaic mode of operation (unbiased) is preferred when a photodiode is used in low frequency applications (up to 350 kHz) as well as ultra low light level applications. In addition to offering a simple operational configuration, the photocurrents in this mode have less variations in responsivity with temperature. An example of an ultra low light level / low speed is shown in **Figure 1.12**.

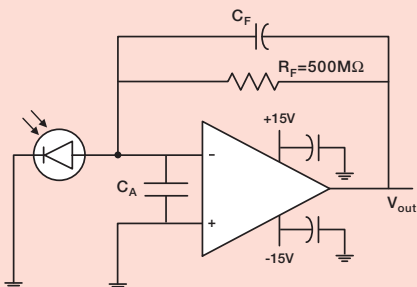

Figure 1.12. Photovoltaic mode of operation circuit example: Low Light Level / Wide Bandwidth

In this example, a FET input operational amplifier as well as a large resistance feedback resistor (R_F) is considered. The detector is unbiased to eliminate any additional noise current. The total output and the op-amp noise current are determined as follows:

$$V_{OUT} = I_P \times R_F$$

$$I_N \left[\frac{A_{rms}}{\sqrt{Hz}} \right] = \sqrt{\frac{4k_B T}{R_F}}$$

where k_B=1.38 x 10⁻²³ J/°K and T is temperature in °K.

For stability, select C_F such that

$$\sqrt{\frac{GBP}{2\pi R_F (C_I + C_F + C_A)}} > \frac{1}{2\pi R_F C_F}$$

Operating bandwidth, after gain peaking compensation is:

$$f_{OP} [Hz] = \frac{1}{2\pi R_F C_F}$$

These examples or any other configurations for single photodiodes can be applied to any of OSI Optoelectronics monolithic, common substrate linear array photodiodes. The output of the first stage pre-amplifiers can be connected to a sample and hold circuit and a multiplexer. **Figure 1.13** shows the block diagram for such configuration.

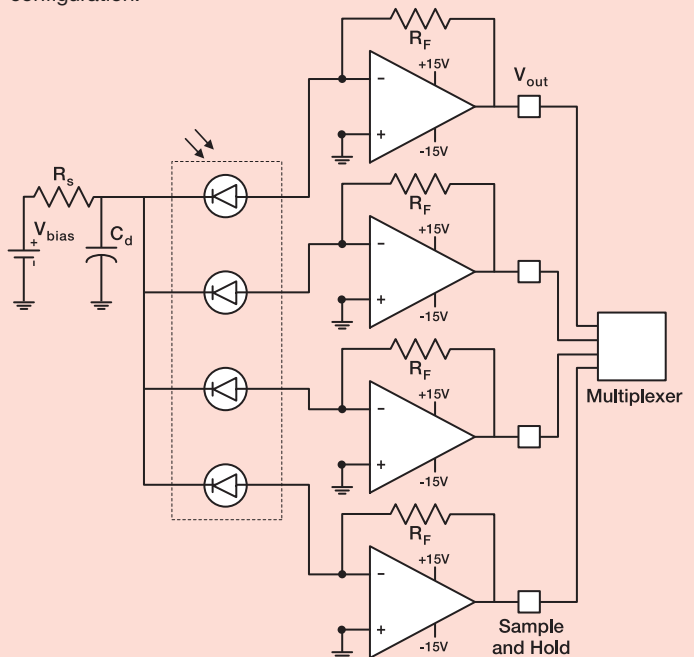

Figure 1.13. Circuit example for a multi-element, common cathode array.

Photodetector with Transimpedance Amplifier

Fiberoptic Receiver Design

One of the most critical part in fiber communication system is receiver of optical signal. Optical receiver determines performance of total system because it is the lowest signal point. Optical system designer must pay special attention when developing receiver part.

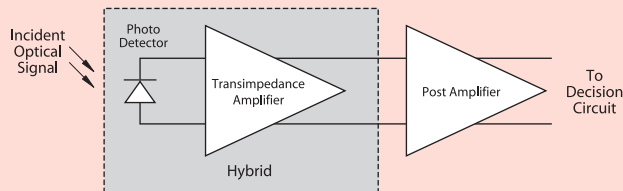

Figure 2.1. Optical Receiver. Functional Block Diagram.

As it is shown on **Figure 2.1**, optical receiver in digital communication system typically contains of Photo Detector, Transimpedance Amplifier (TIA), and Post Amplifier then followed by decision circuit. Photo Detector (PD), typically PIN or Avalanche Photo Diode (APD), produces photocurrent proportional to the incident optical power. Transimpedance amplifier converts this current into voltage signal and then Post Amplifier bring this voltage to some standard level, so Post Amplifier output signal can be used by decision circuit.

In digital optical communication system binary data stream is transmitted by modulation of optical signal. Optical signal with non-return-to-zero (NRZ) coding may have one of two possible state of optical power level during bit time interval. Higher optical power level corresponds to logic level 1, lower level corresponds to 0. In the real system optical power does not equal to zero when transmitting logical 0. Let's assume, that 0 state power equal to P_0 and 1 - state power equal to P_1 as it is indicated on **Figure 2.2**.

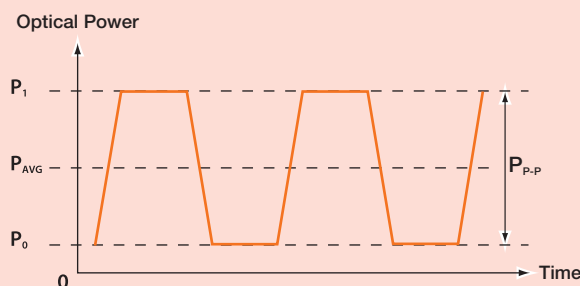

Figure 2.2. Optical Power Levels

The system can be described in terms of Average Power P_{AVG} and Optical Modulation Amplitude or Peak-to-Peak Optical Power P_{P-P} . It is very important to note that we will consider below systems with probabilities to have "one" or "zero" at the output equal to each other (50%). So we can easily determine:

$$P_{AVG} = \frac{P_0 + P_1}{2}$$

$$P_{P-P} = P_1 - P_0$$

Extinction Ratio r_e is the ratio between P_1 and P_0 :

$$r_e = \frac{P_1}{P_0}$$

Extinction ratio can be expressed in terms of dB:

$$r_e (dB) = 10 \log \left(\frac{P_1}{P_0} \right)$$

Then, the average power in terms of peak-to-peak power and extinction ratio is:

$$P_{AVG} = \frac{1 (r_e + 1)}{2 (r_e - 1)} P_{P-P}$$

For example, if the average optical power of the incident signal is $-17dBm$ while extinction ratio is 9dB. Then, $P_{AVG} = 20 \mu W$; $r_e = 7.94$. Peak-to-peak power will be:

$$P_{P-P} = 2 \frac{(r_e - 1)}{(r_e + 1)} P_{AVG}$$

$$P_{P-P} = 2 \frac{(7.94 - 1)}{(7.94 + 1)} \times 20 \mu W$$

$$= 1.55 \times 20 \mu W = 31 \mu W_{P-P}$$

Sensitivity and BER.

Number of errors at the output of decision circuit will determine the quality of the receiver and of course the quality of transmission system. Bit-error-rate (BER) is the ratio of detected bit errors to number of total bit transmitted. Sensitivity S of the optical receiver is determined as a minimum optical power of the incident light signal that is necessary to keep required Bit Error Rate. Sensitivity can be expressed in terms of Average Power (dBm, sometimes μW) with given Extinction Ratio (dB) or in terms of Peak-to-Peak Optical Power (μW_{P-P}). BER requirements are specified for different applications, for example some telecommunication applications specify BER to be 10^{-10} or better; for some data communications it should be equal or better than 10^{-12} .

Noise is one of the most important factors of errors. Noise of PIN Photodiode in digital high-speed application system is typically much less than noise of transimpedance amplifier. Considering thermal noise of TIA as an only noise in such a system usually gives good result for PD/TIA hybrid analysis. We can estimate error probability PE when assuming Gaussian distribution for thermal noise of amplifier:

$$PE = \frac{1}{2} [PE(0|1) + PE(1|0)]$$

where $PE(0|1)$ and $PE(1|0)$ probability to decide 0 instead of 1; and 1 instead of 0 correspondingly when we have equal probabilities for 0 and 1 in our system.

Application Notes

Probability density function D_p for Gaussian distribution is:

$$D_p(\chi) = \frac{1}{\sqrt{2\pi} \cdot \sigma} \exp\left(-\frac{(\chi - \mu)^2}{2\sigma^2}\right)$$

where χ – distribution parameter, σ – is standard deviation, and μ – is mean value. Probability density functions are shown on **Figure 2.3** for two levels of signal.

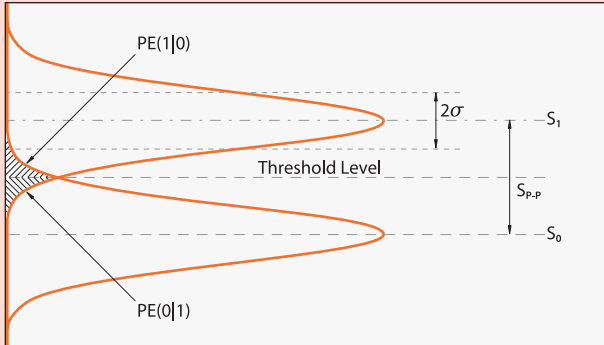

Figure 2.3. Probability Density Functions.

To estimate probability of incorrect decision, for example PE(1|0), we need to integrate density function for 0-distribution above threshold level.

$$PE(1|0) = \int_{\text{Threshold}}^{\infty} D_{p_0}(\chi) d\chi$$

Considering symmetrical distributions (threshold is the half of peak-to-peak signal $S_{p,p}$):

$$PE(1|0) = \int_{S_{p,p}/2}^{\infty} \frac{1}{\sqrt{2\pi} \cdot \sigma} \exp\left(-\frac{\chi^2}{2\sigma^2}\right) d\chi$$

Then normalizing to: $t = \chi / \sigma$

$$PE(1|0) = \int_{S_{p,p}/2\sigma}^{\infty} \frac{1}{\sqrt{2\pi}} \exp\left(-\frac{t^2}{2}\right) dt$$

If deviations for 0 and 1 levels are equal total probability of error will be:

$$PE = \text{erfc}(SNR/2)$$

where $\text{erfc}(x)$ is the complimentary error function:

$$\text{erfc}(x) = \frac{1}{\sqrt{2\pi}} \int_x^{\infty} \exp\left(-\frac{t^2}{2}\right) dt$$

and SNR – signal-to-noise ratio, where signal is in terms of peak-to-peak and noise is an RMS value. Graph of $\text{erfc}(x)$ is shown on **Figure 2.4** and some tabulated SNR numbers vs. BER are given

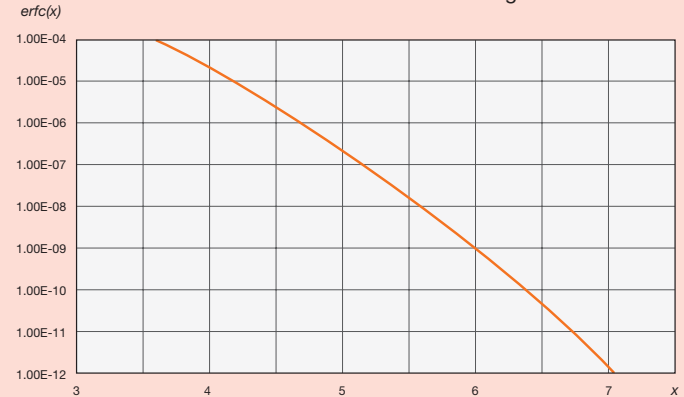

Figure 2.4 Complimentary Error Function

in the **Table 1**. Here we assume that PE = BER, but actual Error Probability equal to BER in ideal system when time of measurements considered being infinite.

BER	10^{-08}	10^{-09}	10^{-10}	10^{-11}	10^{-12}
SNR	11.22	11.99	12.72	13.40	14.06

Table 1

So we can find peak-to-peak signal that we need to achieve required BER.

$$SNR = \frac{I_{p-p}}{I_{N,RMS}} = \frac{P_{p-p} \times R}{I_{N,RMS}}$$

where I_{p-p} is signal photocurrent, R – photodetector responsivity expressed in A/W, $I_{N,RMS}$ – input equivalent RMS noise of TIA.

$$P_{p-p} = \frac{SNR \times I_{N,RMS}}{R}$$

to estimate the sensitivity of PD/TIA at certain BER, we need to find required SNR in the **Table 1** and then calculate average power using equation:

$$S = P_{AVG@BER} = \frac{SNR \times I_{N,RMS}}{2R} \times \frac{(r_e + 1)}{(r_e - 1)}$$

where the first term is the sensitivity with an infinite extinction ratio, and the second is the correction for finite extinction ratio or extinction ratio penalty. Some numbers for extinction ratio penalty are shown in **Table 2**.

r_e , dB	7.00	8.00	9.00	10.00	∞
r_e	5.01	6.31	7.94	10.00	∞
Power Penalty, dB	1.76	1.39	1.10	0.87	0

Table 2

To calculate total receiver sensitivity we have to consider also sensitivity of Post Amplifier or Input Threshold Voltage V_{TH} . Sensitivity of Post Amplifier should be indicated in the Post Amplifier Datasheet and it is usually expressed in peak-to-peak Volts value ($mV_{p,p}$). To achieve the same BER we need to increase peak-to-peak current at least by value of:

$$\Delta I_{PA} = \frac{V_{TH}}{R_{TIA}}$$

where R_{TIA} is transimpedance coefficient of TIA.

Peak-to-peak optical power will be:

$$P_{P-P} = \frac{SNR \times I_{N,RMS} + \Delta I_{PA}}{R}$$

and sensitivity:

$$S = \frac{SNR \times I_{N,RMS} + \frac{V_{TH}}{R_{TIA}}}{2 \cdot R} \times \frac{(r_e + 1)}{(r_e - 1)}$$

Figure 2.5 shows typical sensitivity for InGaAs PD/TIA hybrid alone, typical and minimum sensitivities of the device calculated with 10mV_{p,p} threshold Post Amplifier, and actual measured values for the system with Post Amplifier.

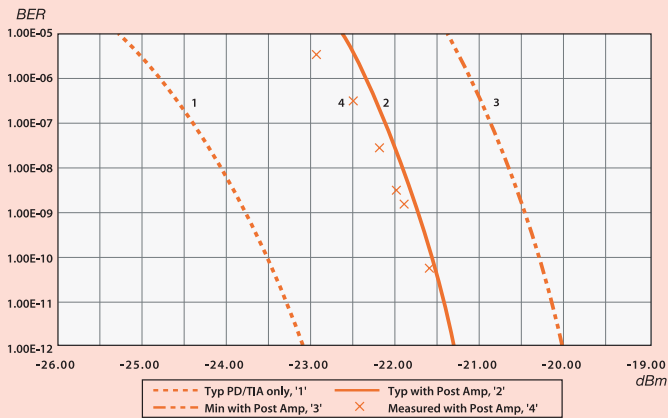

Figure 2.5. InGaAs PD/TIA hybrid: sensitivity for PD/TIA only (curve 1), calculated for PD/TIA with 10mV threshold Post Amplifier typical (curve 2) and minimum (curve 3), and actual measurements for PD/TIA-Post Amplifier system (X-points 4).

For Example, let's calculate the sensitivity for 2.5Gbps InGaAs PD/TIA hybrid at BER=10⁻¹⁰, assuming responsivity of detector to be 0.9 A/W, input RMS noise current of the transimpedance amplifier 500nA, and the extinction ratio of the optical signal 9dB.

First, we will find SNR required to achieve BER=10⁻¹⁰ from the Table 1. Therefore, SNR = 12.72. Then, we can calculate the sensitivity considering $r_e = 7.94$:

$$S = \frac{12.72 \times 0.5\mu A (7.94 + 1)}{2 \times 0.9A/W (7.94 - 1)} = 4.56\mu W$$

or S = -23.4 dBm

For combination of such a PD/TIA Hybrid and Post Amplifier with $V_{TH} = 10$ mV assuming $R_{TIA} = 2.8k\Omega$ sensitivity will be:

$$S = \frac{12.72 \times 0.5\mu A + \left(\frac{10mV}{2.8k\Omega} \right)}{2 \times 0.9A/W} \times \frac{(7.94 + 1)}{(7.94 - 1)} = 7.11\mu W$$

or S = -21.5 dBm. This Post Amplifier threshold affects the sensitivity and the difference is 1.9 dB. Therefore it is very important to take performance and parameters of all discrete receiver components into consideration to analyze the sensitivity of the entire receiver system.

This application note helps to estimate optical front-end performance and to compare receivers' parameters. In the real systems, Jitter, Inter-symbol Interference and other phenomena can affect total system performance.

Actual BER may be different from Error Probability that we dealt with. When measuring actual BER, we have to make sure that large number of bits has been transmitted before obtaining the results. Sometimes, we receive "error envelope", which is a large number of bit errors for a certain short interval with a small amount of errors in previous and next intervals. It happens due to EMI, power surges, etc. that affect total system/equipment performance and measurements result.

We cannot extrapolate Sensitivity vs. BER curves using the data of Table 1 for a system (or conditions) with a nonlinear transfer function, such as a limiting amplifier. We can calculate the sensitivity of a TIA in a linear range, and then modify the results for the system with a limiting amplifier for a certain BER because the threshold of post amplifier is a function of BER.